

# H190-360HD<sub>2</sub>SERIES

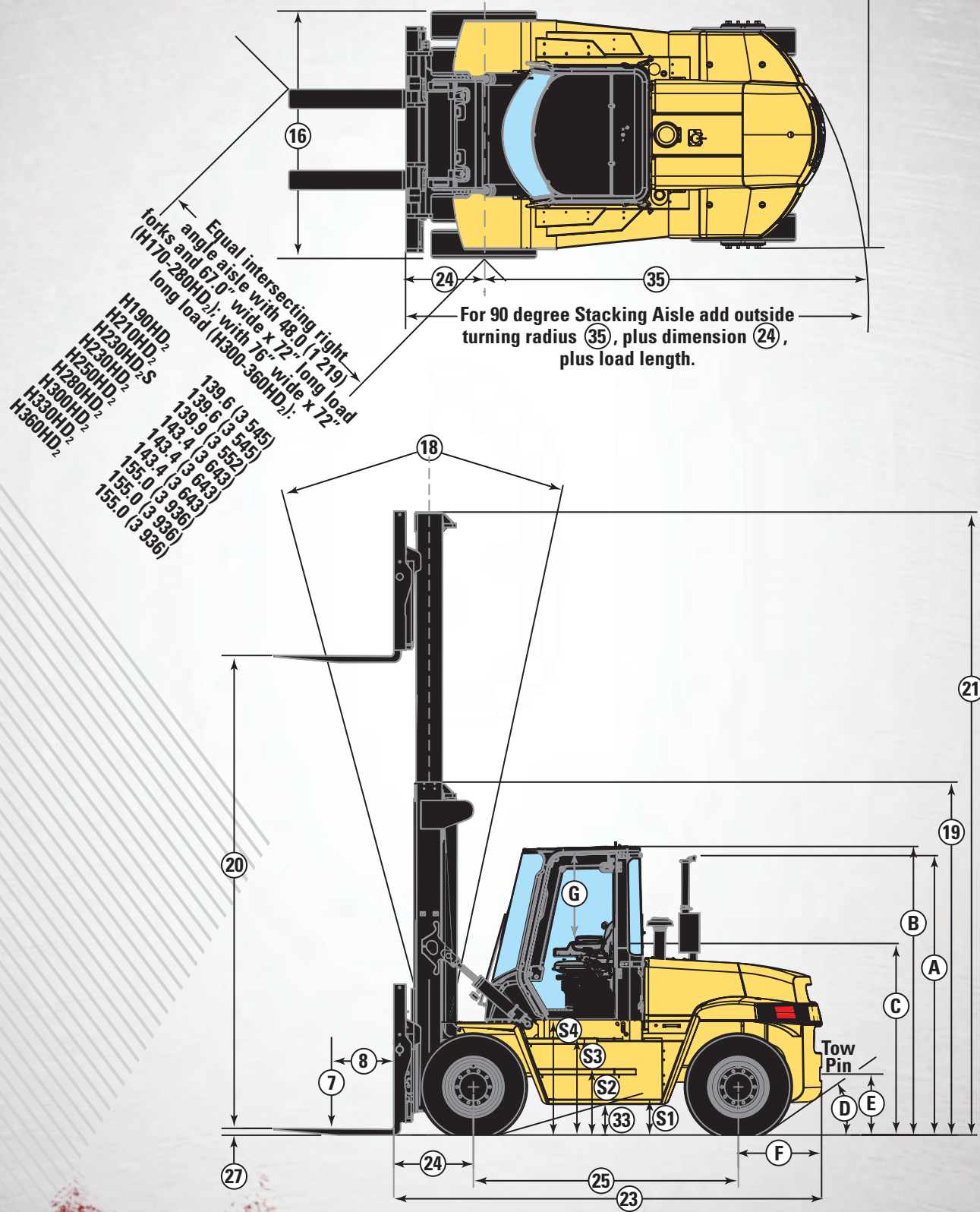

**TECHNICAL GUIDE**  
Heavy-Duty Forklift Truck

# H190HD<sub>2</sub> - H360HD<sub>2</sub> SPECIFICATIONS



# H190HD<sub>2</sub> - H210HD<sub>2</sub> SPECIFICATIONS

GENERAL	HYSTER		HYSTER		
	H190HD <sub>2</sub>		H210HD <sub>2</sub>		
1	Manufacturer	HYSTER		HYSTER	
2	Model designation	H190HD <sub>2</sub>		H210HD <sub>2</sub>	
3	Power: battery, diesel, LPG, electric mains	Diesel		Diesel	
4	Transmission	SOH TE-10	ZF WG161	SOH TE-10	ZF WG161
5	Brake	Air / Drum	Wet Disc	Air / Drum	Wet Disc
6	Operation: manual, pedestrian, stand, sit, seat	Seat		Seat	
7	Load capacity	19000 (8000)		21000 (9000)	
8	Load center	24 (600)		24 (600)	
9	Unladen weight including front end	27318 (12389)		28012 (12389)	
10	Axle loading with load, front/rear	40127 (18198)	4831 (2191)	43333 (19652)	4525 (2052)
11	Axle loading without load, front/rear	13814 (6265)	13503 (6124)	13733 (6228)	14280 (6476)
12	Tires	Pneumatic		Pneumatic	
13	Tire size, front	10.00-20 14PR		10.00-20 14PR	
14	Tire size, rear	10.00-20 14PR		10.00-20 14PR	
15	Number of wheels, front/rear (X = driven)	4X / 2		4X / 2	
16	Tread width, front	86.2 (2190)		86.2 (2190)	
17	Tread width, rear	76.0 (1930)		76.0 (1930)	
18	Mast tilt, a = forward / b = back	15/12		15/12	
19	Height of mast, lowered	165.0 (4179)		165.0 (4179)	
20	Lift height	212.0 (5401)		212.0 (5401)	
21	Height of mast, extended; without LBE	270.0 (6846)		270.0 (6846)	
22	Overhead guard height (including wiper)	118.7 (3015)		118.7 (3015)	
23	Length to face of forks w/std. carriage	169.0 (4292)		169.0 (4292)	
24	Load distance	28.5 (725)		28.5 (725)	
25	Wheelbase	106.3 (2700)		106.3 (2700)	
26	Overall width - dry brake axle/wet brake axle*	97.80 (2484)		97.80 (2484)	
27	Fork dimensions	2.5/8/48.0 (65/200/1220)		2.5/8/48.0 (65/200/1220)	
28	Fork carriage type	2.56 (65) pin type		2.56 (65) pin type	
29	Fork carriage width (without load backrest)	92.5 (2350)		92.5 (2350)	
30	Out to out dimension, fork positioner*	20.5 - 87.8 (520 - 2230)		20.5 - 87.8 (550-2230)	
31	Sideshift from center of truck*	5.9 (150)		5.9 (150)	
32	Ground clearance under mast, with load	9.8 (248)		9.8 (248)	
33	Ground clearance, center of wheelbase	10.8 (274)		10.8 (274)	
34	Aisle width with pallets 1000 x 1200 wide	225.9 (5739)		225.9 (5739)	
35	Outer turning radius	154.1 (3914)		154.1 (3914)	
	Inner turning radius	8.7 (220)		8.7 (220)	
36	Transmission manufacturer/type	SOH TE-10	ZF WG161	SOH TE-10	ZF WG161
37	Travel speed with load	16.4 (26.4)	19.0 (30.5)	16.4 (26.4)	18.8 (30.2)
	Travel speed without load	17.5 (28.1)	19.4 (31.2)	17.5 (28.1)	19.4 (31.2)
38	Lifting speed loaded (Std. Performance)	90.6 (.46)	90.6 (.46)	90.6 (.46)	90.6 (.46)
	Lifting speed unloaded (Std. Performance)	102.4 (.52)	102.4 (.52)	102.4 (.52)	102.4 (.52)
39	Lowering speed loaded (Std. Performance)	98.4 (.50)	98.4 (.50)	98.4 (.50)	98.4 (.50)
	Lowering speed unloaded (Std. Performance)	95.0 (.48)	95.0 (.48)	95.0 (.48)	95.0 (.48)
40	Lifting speed loaded (High Performance)*	N/A	108.3 (.55)	N/A	108.3 (.55)
	Lifting speed unloaded (High Performance)*	N/A	124.0 (.63)	N/A	124.0 (.63)
41	Lowering speed loaded (High Performance)*	N/A	98.4 (.50)	N/A	98.4 (.50)
	Lowering speed unloaded (High Performance)*	N/A	94.5 (.48)	N/A	94.5 (.48)
42	Tilt speed	5.0		5.0	
43	Drawbar pull with load (at 1 mph/1.6km/h)	196907 (89300)	211901 (96100)	190292 (86300)	211239 (95800)
	Drawbar pull without load (at 1 mph/1.6km/h)	79380 (36000)	79380 (36000)	80483 (36500)	80483 (36500)
44	Maximum drawbar pull with load	230643 (104600)	257544 (116800)	230202 (104400)	257544 (116800)
	Maximum drawbar pull without load	79380 (36000)	79380 (36000)	80483 (36500)	80483 (36500)
45	Gradeability with load (at 1 mph/1.6km/h)	51		47	
	Gradeability without load (at 1 mph/1.6km/h)	32		31	
	Gradeability with load	63		57	
	Gradeability without load	32		31	
46	Service brake air brakes / wet brakes	air		wet	
47	Engine manufacturer/type	Cummins QSB6.7		Cummins QSB6.7	
48	Engine output, in accordance with ISO 14396	155 (116)		155 (116)	
49	Engine torque	440/1500 (597/1500)		440/1500 (597/1500)	
50	Governed speed	2300		2300	
51	Number of cylinders/displacement	6/409 (6/6700)		6/409 (6/6700)	
52	Transmission	3-speed autoshift		3-speed autoshift	
53	Working pressure for attachments	2800 (193)		2800 (193)	
54	Oil flow for attachments	26.4 (100)		26.4 (100)	

CERTIFICATION: These Hyster® lift trucks meet design specifications of Part II ANSI B56.1-1969, as required by OSHA Section 1910.178(a)(2) and also comply with Part III ANSI B56.1-revision in effect at time of manufacture. Certification of compliance with the applicable ANSI standards appears on the lift truck. Performance specifications are for a truck equipped as described under Standard Equipment on this Technical Guide. Performance specifications are affected by the condition of the vehicle and how it is equipped, as well as by the nature, condition of the operating area, proper service and maintenance of the vehicle. If these specifications are critical, the proposed application should be discussed with your dealer.

# H230HD<sub>2</sub> - H230HD<sub>2</sub>S SPECIFICATIONS

		HYSTER				HYSTER					
		H230HD <sub>2</sub>		H230HD <sub>2</sub> S		H230HD <sub>2</sub>		H230HD <sub>2</sub> S			
<b>GENERAL</b>	1	Manufacturer		HYSTER		HYSTER		HYSTER			
	2	Model designation		H230HD <sub>2</sub>		H230HD <sub>2</sub> S		H230HD <sub>2</sub> S			
	3	Power: battery, diesel, LPG, electric mains		Diesel		Diesel		Diesel			
	4	Transmission		SOH TE-10		ZF WG161		SOH TE-10		ZF WG161	
	5	Brake		Air / Drum		Wet Disc		Air / Drum		Wet Disc	
	6	Operation: manual, pedestrian, stand, sit, seat		Seat		Seat		Seat		Seat	
<b>WT.</b>	7	Load capacity	lbs (kg)		23000 (10000)		23000 (10000)		23000 (10000)		
	8	Load center	in (mm)		24 (600)		24 (600)		24 (600)		
	9	Unladen weight including front end	lbs (kg)		32169 (14589)		32407 (14697)		32407 (14697)		
	10	Axle loading with load, front/rear	lbs (kg)		48347 (21926)   5872 (2663)		48347 (21926)   5872 (2663)		55778 (25296)   4754 (2156)		
	11	Axle loading without load, front/rear	lbs (kg)		15940 (7229)   16229 (7360)		15940 (7229)   16229 (7360)		15861 (7193)   16546 (7504)		
	<b>WHEELS</b>	12	Tires	Pneumatic		Pneumatic		Pneumatic		Pneumatic	
13		Tire size, front	10.00-20 14PR		10.00-20 14PR		10.00-20 14PR		10.00-20 14PR		
14		Tire size, rear	10.00-20 14PR		10.00-20 14PR		10.00-20 14PR		10.00-20 14PR		
15		Number of wheels, front/rear (X = driven)	4X / 2		4X / 2		4X / 2		4X / 2		
16		Tread width, front	in (mm)		86.2 (2190)		86.2 (2190)		86.2 (2190)		
17		Tread width, rear	in (mm)		76.0 (1930)		76.0 (1930)		76.0 (1930)		
18		Mast tilt, a = forward / b = back	degrees		15/12		15/12		15/12		
19		Height of mast, lowered	in (mm)		176.0 (4453)		176.0 (4453)		176.0 (4453)		
20		Lift height	in (mm)		213.0 (5411)		213.0 (5411)		213.0 (5411)		
21		Height of mast, extended; without LBE	in (mm)		281.0 (7118)		281.0 (7118)		281.0 (7118)		
<b>DIMENSIONS</b>	22	Overhead guard height (including wiper)	in (mm)		119.4 (3033)		119.4 (3033)		119.4 (3033)		
	23	Length to face of forks w/std. carriage	in (mm)		177.0 (4495)		177.0 (4495)		168.1 (4269)		
	24	Overall width - dry brake axle/wet brake axle*	in (mm)		97.80 (2484)		96.30 (2446)		97.80 (2484)		
	25	Load distance	in (mm)		29.9 (760)		29.9 (760)		29.9 (760)		
	26	Wheelbase	in (mm)		114.2 (2900)		114.2 (2900)		106.3 (2700)		
	27	Fork dimensions	in (mm)		3.0/8/48.0 (75/200/1220)		3.0/8/48.0 (75/200/1220)		3.0/8/48.0 (75/200/1220)		
	28	Fork carriage type	in (mm)		2.95 (75) pin type		2.95 (75) pin type		2.95 (75) pin type		
	29	Fork carriage width (without load backrest)	in (mm)		92.5 (2350)		92.5		92.5		
	30	Out to out dimension, fork positioner*	in (mm)		20.5 - 87.8 (520 - 2230)		20.5 - 87.8 (520 - 2230)		20.5 - 87.8 (520 - 2230)		
	31	Sideshift from center of truck*	in (mm)		5.9 (150)		5.9 (150)		5.9 (150)		
<b>PERFORMANCE</b>	32	Ground clearance under mast, with load	in (mm)		8.9 (225)		8.9 (225)		8.9 (225)		
	33	Ground clearance, center of wheelbase	in (mm)		11.5 (292)		11.5 (292)		11.5 (292)		
	34	Aisle width with pallets 1000 x 1200 wide	in (mm)		235.1 (5971)		235.1 (5971)		227.3 (5774)		
	35	Outer turning radius	in (mm)		161.9 (4111)		161.9 (4111)		154.1 (3914)		
	36	Inner turning radius	in (mm)		9.9 (252)		9.9 (252)		8.2 (209)		
	37	Transmission manufacturer/type	SOH TE-10		ZF WG161		SOH TE-10		ZF WG161		
	38	Travel speed with load	mph (kph)		15.5 (25.0)		19.0 (30.6)		15.5 (25.0)		
	39	Travel speed without load	mph (kph)		18.5 (29.7)		19.9 (32.0)		18.5 (29.7)		
	40	Lifting speed loaded (Std. Performance)	fpm (m/sec)		68.9 (.35)		68.9 (.35)		68.9 (.35)		
	41	Lifting speed unloaded (Std. Performance)	fpm (m/sec)		78.7 (.40)		78.7 (.40)		78.7 (.40)		
<b>ENGINE</b>	42	Lowering speed loaded (Std. Performance)	fpm (m/sec)		96.5 (.49)		96.5 (.49)		96.5 (.49)		
	43	Lowering speed unloaded (Std. Performance)	fpm (m/sec)		91.0 (.46)		91.0 (.46)		91.0 (.46)		
	44	Lifting speed loaded (High Performance)*	fpm (m/sec)		N/A		82.7 (.42)		N/A		
	45	Lifting speed unloaded (High Performance)*	fpm (m/sec)		N/A		94.5 (.48)		N/A		
	46	Lowering speed loaded (High Performance)*	fpm (m/sec)		N/A		98.4 (.50)		N/A		
	47	Lowering speed unloaded (High Performance)*	fpm (m/sec)		N/A		90.6 (.46)		N/A		
	48	Tilt speed	deg/sec		5.0		5.0		5.0		
	49	Drawbar pull with load (at 1 mph/1.6km/h)	lbs (kg)		189189 (85800)		67473 (30600)		189189 (85800)		
	50	Drawbar pull without load (at 1 mph/1.6km/h)	lbs (kg)		90846 (41200)		90846 (41200)		90846 (41200)		
	51	Maximum drawbar pull with load	lbs (kg)		220059 (99800)		243432 (110400)		220059 (99800)		
<b>OTHER</b>	52	Maximum drawbar pull without load	lbs (kg)		90846 (41200)		90846 (41200)		90846 (41200)		
	53	Gradeability with load (at 1 mph/1.6km/h)	%		38		40		38		
	54	Gradeability without load (at 1 mph/1.6km/h)	%		31		31		31		
	55	Gradeability with load	%		46		49		46		
	56	Gradeability without load	%		31		31		31		
	57	Service brake air brakes / wet brakes	air		air		wet		air		
	58	Engine manufacturer/type	Cummins QSB6.7		Cummins QSB6.7		Cummins QSB6.7		Cummins QSB6.7		
	59	Engine output, in accordance with ISO 14396	hp (kW)		155 (116)		155 (116)		155 (116)		
	60	Engine torque	lb-ft/rpm (Nm/rpm)		440/1500 (597/1500)		440/1500 (597/1500)		440/1500 (597/1500)		
	61	Governed speed	rpm		2300		2300		2300		
62	Number of cylinders/displacement	in <sup>3</sup> (cm <sup>3</sup> )		6/409 (6/6700)		6/409 (6/6700)		6/409 (6/6700)			
63	Transmission	3-speed autoshift		3-speed autoshift		3-speed autoshift		3-speed autoshift			
64	Working pressure for attachments	psi (bar)		2800 (193)		2800 (193)		2800 (193)			
65	Oil flow for attachments	gpm (l/min)		26.4 (100)		26.4 (100)		26.4 (100)			

**CERTIFICATION:** These Hyster® lift trucks meet design specifications of Part II ANSI B56.1-1969, as required by OSHA Section 1910.178(a)(2) and also comply with Part III ANSI B56.1-revision in effect at time of manufacture. Certification of compliance with the applicable ANSI standards appears on the lift truck. Performance specifications are for a truck equipped as described under Standard Equipment on this Technical Guide. Performance specifications are affected by the condition of the vehicle and how it is equipped, as well as by the nature, condition of the operating area, proper service and maintenance of the vehicle. If these specifications are critical, the proposed application should be discussed with your dealer.

# H250HD<sub>2</sub> - H280HD<sub>2</sub> SPECIFICATIONS

GENERAL	H250HD <sub>2</sub>		H280HD <sub>2</sub>	
	1	HYSTER		HYSTER
2	H250HD <sub>2</sub>		H280HD <sub>2</sub>	
3	Diesel		Diesel	
4	SOH TE-10	ZF WG161	SOH TE-10	ZF WG161
5	Air / Drum	Wet Disc	Air / Drum	Wet Disc
6	Seat		Seat	
7	25000 (12000)		28000 (12000)	
8	24 (600)		24 (600)	
9	32581 (15444)		34054 (15444)	
10	52772 (24773)	4810 (2672)	52772 (24773)	4810 (2672)
11	15938 (7136)	16643 (8308)	15938 (7136)	16643 (8308)
12	Pneumatic		Pneumatic	
13	10.00-20 14PR		10.00-20 14PR	
14	10.00-20 14PR		10.00-20 14PR	
15	4X/2		4X/2	
16	86.2 (2190)		86.2 (2190)	
17	76.0 (1930)		76.0 (1930)	
18	15/12		15/12	
19	176.0 (4453)		176.0 (4453)	
20	213.0 (5411)		213.0 (5411)	
21	281.0 (7118)		281.0 (7118)	
22	119.4 (3033)		119.4 (3033)	
23	177.0 (4495)		177.0 (4495)	
24	97.80 (2484)		97.80 (2484)	
25	29.9 (760)		29.9 (760)	
26	114.2 (2900)		114.2 (2900)	
27	3.0/8/48.0 (75/200/1220)		3.0/8/48.0 (75/200/1220)	
28	2.95 (75) pin type		2.95 (75) pin type	
29	92.5 (2350)		92.5 (2350)	
30	20.5 - 87.8 (520-2230)		20.5 - 87.8 (520-2230)	
31	5.9 (150)		5.9 (150)	
32	8.9 (225)		8.9 (225)	
33	11.5 (292)		11.5 (292)	
34	235.1 (5971)		235.1 (5971)	
35	161.9 (4111)		161.9 (4111)	
36	9.9 (252)		9.9 (252)	
37	SOH TE-10		ZF WG161	
38	15.5 (25.0)		18.8 (30.3)	
39	18.5 (29.7)		19.9 (32.0)	
40	68.9 (.35)		68.9 (.35)	
41	78.7 (.40)		78.7 (.40)	
42	96.5 (.49)		96.5 (.49)	
43	91.0 (.46)		91.0 (.46)	
44	N/A		82.7 (.42)	
45	N/A		94.5 (.48)	
46	N/A		98.4 (.50)	
47	N/A		90.6 (.46)	
48	5.0		5.0	
49	187866 (85200)		198450 (90000)	
50	99005 (44900)		99005 (44900)	
51	218736 (99200)		243432 (110400)	
52	99005 (44900)		99005 (44900)	
53	32		34	
54	30		30	
55	38		46	
56	30		30	
57	air		wet	
58	Cummins QSB6.7		Cummins QSB6.7	
59	155 (116)		155 (116)	
60	440/1500 (597/1500)		440/1500 (597/1500)	
61	2300		2300	
62	6/409 (6/6700)		6/409 (6/6700)	
63	3-speed autoshift		3-speed autoshift	
64	2800 (193)		2800 (193)	
65	26.4 (100)		26.4 (100)	

CERTIFICATION: These Hyster® lift trucks meet design specifications of Part II ANSI B56.1-1969, as required by OSHA Section 1910.178(a)(2) and also comply with Part III ANSI B56.1-revision in effect at time of manufacture. Certification of compliance with the applicable ANSI standards appears on the lift truck. Performance specifications are for a truck equipped as described under Standard Equipment on this Technical Guide. Performance specifications are affected by the condition of the vehicle and how it is equipped, as well as by the nature, condition of the operating area, proper service and maintenance of the vehicle. If these specifications are critical, the proposed application should be discussed with your dealer.

# H300HD<sub>2</sub> - H330HD<sub>2</sub> SPECIFICATIONS

GENERAL	WT.	HYSTER				HYSTER			
		H300HD <sub>2</sub>		H330HD <sub>2</sub>		H300HD <sub>2</sub>		H330HD <sub>2</sub>	
1	Manufacturer	HYSTER				HYSTER			
2	Model designation	H300HD <sub>2</sub>				H330HD <sub>2</sub>			
3	Power: battery, diesel, LPG, electric mains	Diesel				Diesel			
4	Transmission	SOH TE-10		ZF WG161		SOH TE-10		ZF WG161	
5	Brake	Air / Drum		Wet Disc		Air / Drum		Wet Disc	
6	Operation: manual, pedestrian, stand, sit, seat	Seat				Seat			
7	Load capacity	30000 (13000)		30000 (13000)		33000 (14000)		33000 (14000)	
8	Load center	24 (600)				24 (600)			
9	Unladen weight including front end	39825 (18061)				41436 (18792)			
10	Axle loading with load, front/rear	63352 (28731)	5138 (2330)	63352 (28731)	5138 (2330)	66646 (30225)	5660 (2567)	66646 (30225)	5660 (2567)
11	Axle loading without load, front/rear	21988 (9972)	17836 (8089)	21988 (9972)	17836 (8089)	22101 (10023)	19336 (8769)	22101 (10023)	19336 (8769)
12	Tires	Pneumatic		Pneumatic		Pneumatic		Pneumatic	
13	Tire size, front	12.00-20 16PR		12.00-20 16PR		12.00-20 16PR		12.00-20 16PR	
14	Tire size, rear	12.00-20 16PR		12.00-20 16PR		12.00-20 16PR		12.00-20 16PR	
15	Number of wheels, front/rear (X = driven)	4X / 2		4X / 2		4X / 2		4X / 2	
16	Tread width, front	89.6 (2276)		89.6 (2276)		89.6 (2276)		89.6 (2276)	
17	Tread width, rear	78.7 (2000)		78.7 (2000)		78.7 (2000)		78.7 (2000)	
18	Mast tilt, a = forward / b = back	15/12		15/12		15/12		15/12	
19	Height of mast, lowered	176.0 (4466)		176.0 (4466)		176.0 (4466)		176.0 (4466)	
20	Lift height	212.0 (5400)		212.0 (5400)		212.0 (5400)		212.0 (5400)	
21	Height of mast, extended; without LBE	281.0 (7120)		281.0 (7120)		281.0 (7120)		281.0 (7120)	
22	Overhead guard height (including wiper)	119.8 (3043)		119.8 (3043)		120.6 (3064)		120.6 (3064)	
23	Length to face of forks w/std. carriage	197.0 (5004)		197.0 (5004)		197.0 (5004)		197.0 (5004)	
24	Load distance	33.9 (862)				33.9 (862)			
25	Wheelbase	129.9 (3300)				129.9 (3300)			
26	Overall width - dry brake axle/wet brake axle*	102.64 (2607)		102.64 (2607)		102.64 (2607)		102.64 (2607)	
27	Fork dimensions	3.5/8/60 (90/200/1525)		3.5/8/60 (90/200/1525)		3.5/8/60 (90/200/1525)		3.5/8/60 (90/200/1525)	
28	Fork carriage type	3.35 (85) pin type		3.35 (85) pin type		3.35 (85) pin type		3.35 (85) pin type	
29	Fork carriage width (without load backrest)	98.4 (2500)		98.4 (2500)		98.4 (2500)		98.4 (2500)	
30	Out to out dimension, fork positioner*	20.5 - 93.7 (520-2380)		20.5 - 93.7 (520-2380)		20.5 - 93.7 (520-2380)		20.5 - 93.7 (520-2380)	
31	Sideshift from center of truck*	5.9 (150)		5.9 (150)		5.9 (150)		5.9 (150)	
32	Ground clearance under mast, with load	6.2 (157)		6.2 (157)		7.0 (178)		7.0 (178)	
33	Ground clearance, center of wheelbase	12.8 (325)		12.8 (325)		13.6 (346)		13.6 (346)	
34	Aisle width with pallets 1000 x 1200 wide	257.7 (6546)		257.7 (6546)		257.7 (6546)		257.7 (6546)	
35	Outer turning radius	180.5 (4584)		180.5 (4584)		180.5 (4584)		180.5 (4584)	
	Inner turning radius	18.1 (459)		18.1 (459)		18.0 (458)		18.0 (458)	
36	Transmission manufacturer/type	SOH TE-10		ZF WG161		SOH TE-10		ZF WG161	
37	Travel speed with load	15.2 (24.5)		16.5 (26.6)		14.5 (23.4)		16.5 (26.6)	
	Travel speed without load	17.2 (27.6)		17.4 (28.0)		17.0 (27.3)		17.4 (28.0)	
38	Lifting speed loaded (Std. Performance)	55.1 (.28)		55.1 (.28)		55.1 (.28)		55.1 (.28)	
	Lifting speed unloaded (Std. Performance)	84.0 (.42)		84.0 (.42)		84.0 (.42)		84.0 (.42)	
39	Lowering speed loaded (Std. Performance)	94.5 (.48)		94.5 (.48)		94.5 (.48)		94.5 (.48)	
	Lowering speed unloaded (Std. Performance)	87.0 (.44)		87.0 (.44)		87.0 (.44)		87.0 (.44)	
40	Lifting speed loaded (High Performance)*	N/A		66.9 (.34)		N/A		66.9 (.34)	
	Lifting speed unloaded (High Performance)*	N/A		98.4 (.50)		N/A		98.4 (.50)	
41	Lowering speed loaded (High Performance)*	N/A		98.4 (.50)		N/A		98.4 (.50)	
	Lowering speed unloaded (High Performance)*	N/A		90.6 (.46)		N/A		90.6 (.46)	
42	Tilt speed	3.9		3.9		3.9		3.9	
43	Drawbar pull with load (at 1 mph/1.6km/h)	215429 (97700)		233951 (106100)		207050 (94300)		225351 (102200)	
	Drawbar pull without load (at 1 mph/1.6km/h)	113337 (51400)		113337 (51400)		118629 (52900)		118629 (52900)	
44	Maximum drawbar pull with load	261513 (118600)		287312 (130300)		249165 (113400)		275405 (124900)	
	Maximum drawbar pull without load	113337 (51400)		113337 (51400)		118629 (52900)		116645 (52900)	
45	Gradeability with load (at 1 mph/1.6km/h)	36		38		31		33	
	Gradeability without load (at 1 mph/1.6km/h)	33		33		33		33	
	Gradeability with load	45		46		38		41	
	Gradeability without load	33		33		33		33	
46	Service brake air brakes / wet brakes	air		wet		air		wet	
47	Engine manufacturer/type	Cummins QSB6.7		Cummins QSB6.7		Cummins QSB6.7		Cummins QSB6.7	
48	Engine output, in accordance with ISO 14396	155 (116)		155 (116)		155 (116)		155 (116)	
49	Engine torque	440/1500 (597/1500)		440/1500 (597/1500)		440/1500 (597/1500)		440/1500 (597/1500)	
50	Governed speed	2300		2300		2300		2300	
51	Number of cylinders/displacement	6/409 (6/6700)		6/409 (6/6700)		6/409 (6/6700)		6/409 (6/6700)	
52	Transmission	3-speed autoshift		3-speed autoshift		3-speed autoshift		3-speed autoshift	
53	Working pressure for attachments	2800 (193)		2800 (193)		2800 (193)		2800 (193)	
54	Oil flow for attachments	26.4 (100)		26.4 (100)		26.4 (100)		26.4 (100)	

**CERTIFICATION:** These Hyster® lift trucks meet design specifications of Part II ANSI B56.1-1969, as required by OSHA Section 1910.178(a)(2) and also comply with Part III ANSI B56.1-revision in effect at time of manufacture. Certification of compliance with the applicable ANSI standards appears on the lift truck. Performance specifications are for a truck equipped as described under Standard Equipment on this Technical Guide. Performance specifications are affected by the condition of the vehicle and how it is equipped, as well as by the nature, condition of the operating area, proper service and maintenance of the vehicle. If these specifications are critical, the proposed application should be discussed with your dealer.

# H360HD<sub>2</sub> SPECIFICATIONS

<b>GENERAL</b>	1	Manufacturer	HYSTER			
	2	Model designation	H360HD <sub>2</sub>			
	3	Power: battery, diesel, LPG, electric mains	Diesel			
	4	Transmission	SOH TE-10		ZF WG161	
	5	Brake	Air / Drum		Wet Disc	
	6	Operation: manual, pedestrian, stand, sit, seat	Seat			
<b>WT.</b>	7	Load capacity	lbs (kg) 36000 (16000)			
	8	Load center	in (mm) 24 (600)			
	9	Unladen weight including front end	lbs (kg) 43763 (19847)			
<b>WHEELS</b>	10	Axle loading with load, front/rear	72966 (33091)   6077 (2756)		72966 (33091)   6077 (2756)	
	11	Axle loading without load, front/rear	22054 (10002)   21708 (9845)		22054 (10002)   21708 (9845)	
	12	Tires	Pneumatic		Pneumatic	
	13	Tire size, front	12.00-20 16PR		12.00-20 16PR	
	14	Tire size, rear	12.00-20 16PR		12.00-20 16PR	
	15	Number of wheels, front/rear (X = driven)	4X / 2		4X / 2	
	16	Tread width, front	in (mm) 89.6 (2276)		89.6 (2276)	
	17	Tread width, rear	in (mm) 78.7 (2000)		78.7 (2000)	
	18	Mast tilt, a = forward / b = back	degrees 15/12		15/12	
	19	Height of mast, lowered	in (mm) 176.0 (4466)		176.0 (4466)	
	20	Lift height	in (mm) 212.0 (5400)		212.0 (5400)	
21	Height of mast, extended; without LBE	in (mm) 281.0 (7120)		281.0 (7120)		
22	Overhead guard height (including wiper)	in (mm) 120.6 (3064)		120.6 (3064)		
23	Length to face of forks w/std. carriage	in (mm) 197.0 (5004)		197.0 (5004)		
<b>DIMENSIONS</b>	24	Load distance	in (mm) 33.9 (862)			
	25	Wheelbase	in (mm) 129.9 (3300)			
	26	Overall width - dry brake axle/wet brake axle*	in (mm) 102.64 (2607)		102.64 (2607)	
	27	Fork dimensions	in (mm) 3.5/8/60 (90/200/1525)		3.5/8/60 (90/200/1525)	
	28	Fork carriage type	in (mm) 3.35 (85) pin type		3.35 (85) pin type	
	29	Fork carriage width (without load backrest)	in (mm) 98.4 (2500)			
	30	Out to out dimension, fork positioner*	in (mm) 20.5 - 93.7 (520-2380)		20.5 - 93.7 (520-2380)	
	31	Sideshift from center of truck*	in (mm) 5.9 (150)			
	32	Ground clearance under mast, with load	in (mm) 7.0 (178)			
	33	Ground clearance, center of wheelbase	in (mm) 13.6 (346)			
	34	Aisle width with pallets 1000 x 1200 wide	in (mm) 257.7 (6546)			
	35	Outer turning radius	in (mm) 180.5 (4584)			
	36	Inner turning radius	in (mm) 18.0 (458)			
	<b>PERFORMANCE</b>	36	Transmission manufacturer/type	SOH TE-10		ZF WG161
37		Travel speed with load	mph (kph) 14.5 (23.4)		16.3 (26.3)	
		Travel speed without load	mph (kph) 17.0 (27.3)		17.3 (27.9)	
38		Lifting speed loaded (Std. Performance)	fpm (m/sec) 55.1 (.28)			
		Lifting speed unloaded (Std. Performance)	fpm (m/sec) 84.0 (.42)			
39		Lowering speed loaded (Std. Performance)	fpm (m/sec) 94.5 (.48)			
		Lowering speed unloaded (Std. Performance)	fpm (m/sec) 87.0 (.44)			
40		Lifting speed loaded (High Performance)*	fpm (m/sec) 66.9 (.34)			
		Lifting speed unloaded (High Performance)*	fpm (m/sec) 98.4 (.50)			
41		Lowering speed loaded (High Performance)*	fpm (m/sec) 98.4 (.50)			
		Lowering speed unloaded (High Performance)*	fpm (m/sec) 90.6 (.46)			
42		Tilt speed	deg/sec 3.9			
43		Drawbar pull with load (at 1 mph/1.6km/h)	lbs (kg) 207050 (93900)		224028 (101600)	
		Drawbar pull without load (at 1 mph/1.6km/h)	lbs (kg) 118629 (53800)		118629 (53800)	
44		Maximum drawbar pull with load	lbs (kg) 249165 (113000)		275405 (124900)	
		Maximum drawbar pull without load	lbs (kg) 118629 (53800)		118629 (53800)	
45		Gradeability with load (at 1 mph/1.6km/h)	% 28			
	Gradeability without load (at 1 mph/1.6km/h)	% 31				
	Gradeability with load	% 35				
	Gradeability without load	% 31				
46	Service brake air brakes / wet brakes	air		wet		
<b>ENGINE</b>	47	Engine manufacturer/type	Cummins QSB6.7		Cummins QSB6.7	
	48	Engine output, in accordance with ISO 14396	hp (kW) 155 (116)			
	49	Engine torque	lb-ft/rpm (Nm/rpm) 440/1500 (597/1500)		440/1500 (597/1500)	
	50	Governed speed	rpm 2300			
	51	Number of cylinders/displacement	in <sup>3</sup> (cm <sup>3</sup> ) 6/409 (6/6700)		6/409 (6/6700)	
<b>OTHER</b>	52	Transmission	3-speed autoshift			
	53	Working pressure for attachments	psi (bar) 2800 (193)			
	54	Oil flow for attachments	gpm (l/min) 26.4 (100)			

**CERTIFICATION:** These Hyster® lift trucks meet design specifications of Part II ANSI B56.1-1969, as required by OSHA Section 1910.178(a)(2) and also comply with Part III ANSI B56.1-revision in effect at time of manufacture. Certification of compliance with the applicable ANSI standards appears on the lift truck. Performance specifications are for a truck equipped as described under Standard Equipment on this Technical Guide. Performance specifications are affected by the condition of the vehicle and how it is equipped, as well as by the nature, condition of the operating area, proper service and maintenance of the vehicle. If these specifications are critical, the proposed application should be discussed with your dealer.

# H190HD<sub>2</sub> - H360HD<sub>2</sub> MAST DIMENSIONS

## H190-210HD<sub>2</sub>, MAST DIMENSIONS in. (mm)

Maximum Fork Height (Top of Forks)	Overall Lowered Height	Overall Extended Height without Load Backrest Ext.	Full Free-Lift	Approx. Total Wgt. of Standard Equipped Truck w/o Load	
				H190HD <sub>2</sub> lb. (kg)	H210HD <sub>2</sub> lb. (kg)
<b>2-STAGE NO FREE-LIFT (NO FL) VISTA®</b>					
147 (3751)	133 (3353)	205 (5196)	N/A	26764 (12140)	27459 (12455)
183 (4651)	150 (3803)	240 (6096)	N/A	27267 (12368)	27961 (12683)
212 (5401)	165 (4178)	270 (6846)	N/A	27500 (12474)	28915 (12879)
<b>3-STAGE VISTA®</b>					
220 (5600)	120 (3045)	277 (7073)	56 (1435)	36367 (16496)	37062 (16811)
236 (6000)	126 (3178)	293 (7430)	61 (1568)	37249 (16896)	37944 (17211)
255 (6500)	132 (3345)	313 (7930)	68 (1735)	38352 (17396)	39046 (17711)
275 (7000)	139 (3511)	332 (8430)	74 (1901)	39454 (17896)	40148 (18211)

## H230-280HD<sub>2</sub>, MAST DIMENSIONS in. (mm)

Maximum Fork Height (Top of Forks)	Overall Lowered Height	Overall Extended Height without Load Backrest Ext.	Full Free-Lift	Approx. Total Wgt. of Standard Equipped Truck w/o Load			
				H230HD <sub>2</sub> S lb. (kg)	H230HD <sub>2</sub> lb. (kg)	H250HD <sub>2</sub> lb. (kg)	H280HD <sub>2</sub> lb. (kg)
<b>2-STAGE NO FREE-LIFT (NO FL) VISTA®</b>							
148 (3761)	143 (3628)	216 (5468)	N/A	31425 (14254)	31189 (14147)	31575 (14322)	33074 (15002)
183 (4661)	161 (4078)	251 (6368)	N/A	31901 (14470)	31665 (14363)	32051 (14538)	33550 (15218)
213 (5411)	176 (4453)	281 (7118)	N/A	32377 (14686)	32141 (14579)	32527 (14754)	34026 (15434)
244 (6205)	192 (4853)	312 (7918)	N/A	32774 (14866)	32538 (14759)	32924 (14934)	34423 (15614)
<b>3-STAGE VISTA®</b>							
220 (5600)	120 (3045)	277 (7073)	56 (1435)	39494 (17914)	39258 (17807)	39644 (17982)	41143 (18662)
236 (6000)	126 (3178)	293 (7430)	61 (1568)	40375 (18314)	40140 (18207)	40525 (18382)	42025 (19062)
255 (6500)	132 (3345)	313 (7930)	68 (1735)	41478 (18814)	41242 (18707)	41628 (18882)	43127 (19562)
275 (7000)	139 (3511)	332 (8430)	74 (1901)	42580 (19314)	42344 (19207)	42730 (19382)	44229 (20062)

## H300-360HD<sub>2</sub>, MAST DIMENSIONS in. (mm)

Maximum Fork Height (Top of Forks)	Overall Lowered Height	Overall Extended Height without Load Backrest Ext.	Full Free-Lift	Approx. Total Wgt. of Standard Equipped Truck w/o Load		
				H300HD <sub>2</sub> lb. (kg)	H330HD <sub>2</sub> lb. (kg)	H360HD <sub>2</sub> lb. (kg)
<b>2-STAGE NO FREE-LIFT (NO FL) VISTA®</b>						
147 (3750)	144 (3641)	216 (5470)	N/A	37749 (17123)	39361 (17854)	41687 (18609)
183 (4650)	162 (4091)	251 (6370)	N/A	38382 (17410)	39994 (18141)	42320 (19196)
212 (5400)	176 (4466)	281 (7120)	N/A	39026 (17702)	40368 (18433)	42963 (19488)
244 (6200)	192 (4866)	312 (7920)	N/A	39509 (17921)	41120 (18652)	43446 (19707)
<b>3-STAGE VISTA®</b>						
173 (4400)	121 (3070)	240 (6080)	54 (1390)	39476 (17906)	41087 (18637)	43413 (19692)
196 (5000)	129 (3270)	263 (6680)	62 (1590)	39747 (18029)	41358 (18760)	43684 (19815)
236 (6000)	142 (3600)	303 (7680)	75 (1920)	40201 (18235)	41813 (18966)	44138 (20021)
275 (7000)	156 (3940)	342 (8680)	88 (2250)	41096 (18641)	42708 (19372)	45034 (20427)



# HYSTER H190HD<sub>2</sub> - H210HD<sub>2</sub> LIFT TRUCK RATED CAPACITIES

Model H190HD<sub>2</sub>: 19,000 lbs. at 24" (8,618 kg at 600 mm) load center.

Model H210HD<sub>2</sub>: 21,000 lbs. at 24" (9,525 kg at 600 mm) load center.

Rated capacities are for trucks equipped with:

- VISTA® mast to 212.0" (5400 mm) (H190-210HD<sub>2</sub>) maximum fork height
- 92.5" (2,350 mm) (H190-280HD<sub>2</sub>) carriage
- 48.0" (1,219 mm) (H190-280HD<sub>2</sub>) long forks as required

Contact your dealer for other capacity information.

## RATED LOAD VS. LOAD CENTER

Standard Pin Carriage  
U.S. CUSTOMARY

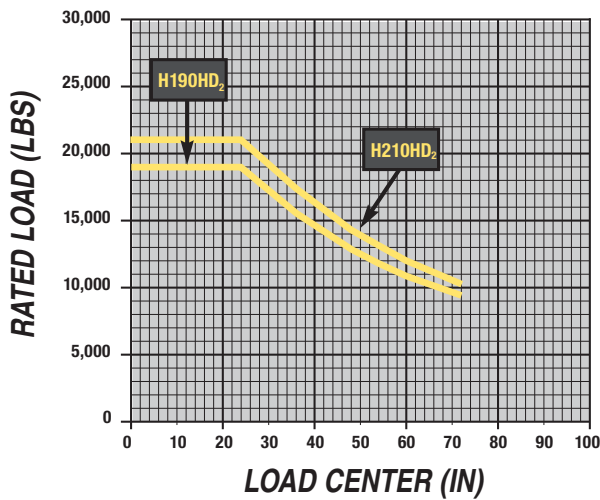

## RATED LOAD VS. LOAD CENTER

Non-Sideshift Fork Positioning Carriage  
U.S. CUSTOMARY

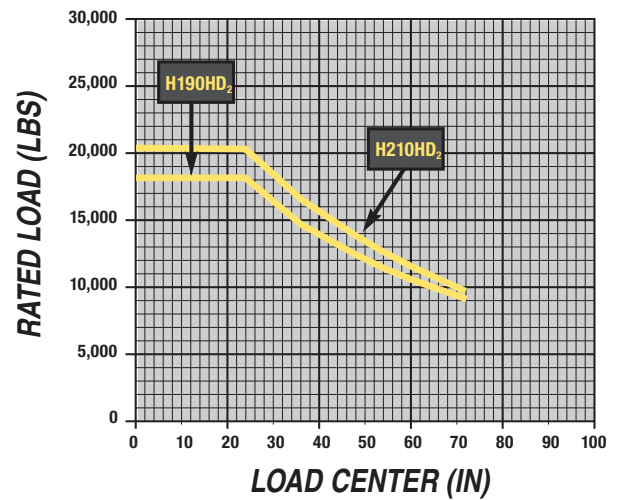

## RATED LOAD VS. LOAD CENTER

Integral Sideshift Carriage & Apron Style  
Sideshifting Fork Positioning Carriage  
U.S. CUSTOMARY

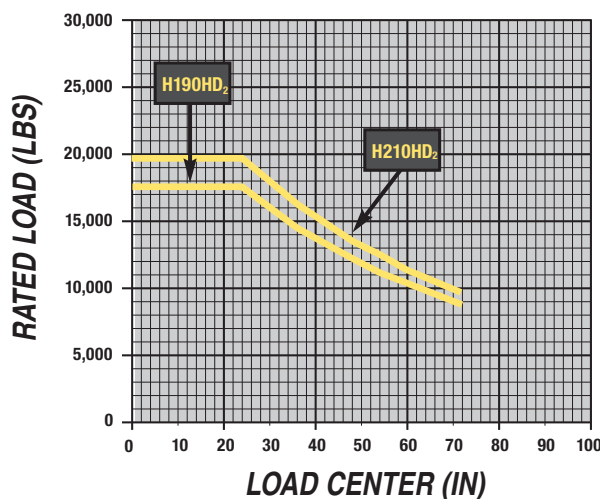

## RATED LOAD VS. LOAD CENTER

Dual Function Sideshifting /  
Fork Positioning Carriage  
U.S. CUSTOMARY

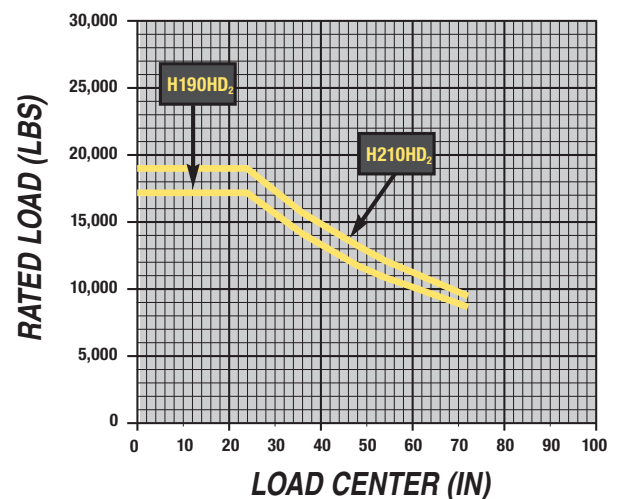

Conversion Factor: 1.0" = 25.4 mm; 1 lb = 0.45 kg

# HYSTER H230HD<sub>2</sub> - H280HD<sub>2</sub> LIFT TRUCK RATED CAPACITIES

Model H230HD<sub>2</sub>: 23,000 lbs. at 24" (10,433 kg at 600 mm) load center.  
 Model H230HD<sub>2</sub>S: 23,000 lbs. at 24" (10,433 kg at 600 mm) load center.  
 Model H250HD<sub>2</sub>: 25,000 lbs. at 24" (11,340 kg at 600 mm) load center.  
 Model H280HD<sub>2</sub>: 28,000 lbs. at 24" (12,701 kg at 600 mm) load center.

Rated capacities are for trucks equipped with:

- VISTA® mast to 213.0" (5 411mm) (230-280HD<sub>2</sub>) maximum fork height
- 92.5" (2,350 mm) (H190-280HD<sub>2</sub>) carriage
- 48.0" (1,219 mm) (H190-280HD<sub>2</sub>) long forks as required

Contact your dealer for other capacity information.

## RATED LOAD VS. LOAD CENTER

Standard Pin Carriage  
 U.S. CUSTOMARY

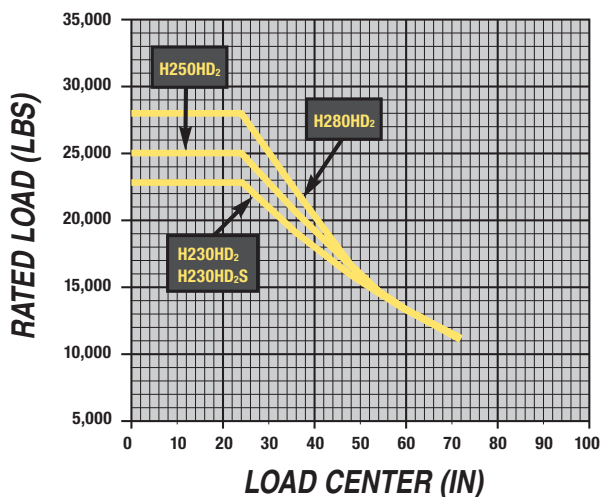

## RATED LOAD VS. LOAD CENTER

Non-Sideshift Fork Positioning Carriage  
 U.S. CUSTOMARY

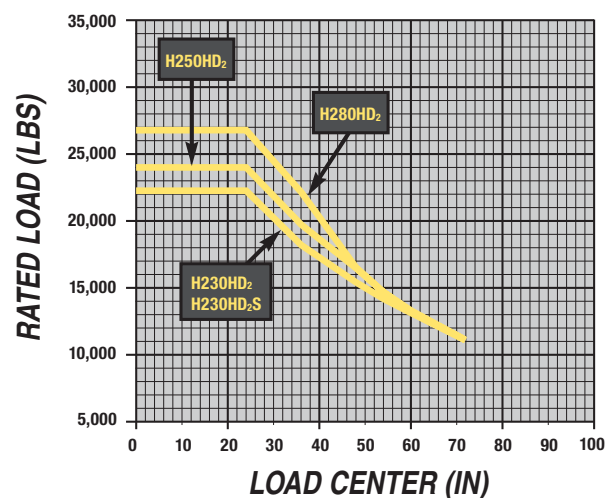

## RATED LOAD VS. LOAD CENTER

Integral Sideshift Carriage & Apron Style  
 Sideshifting Fork Positioning Carriage  
 U.S. CUSTOMARY

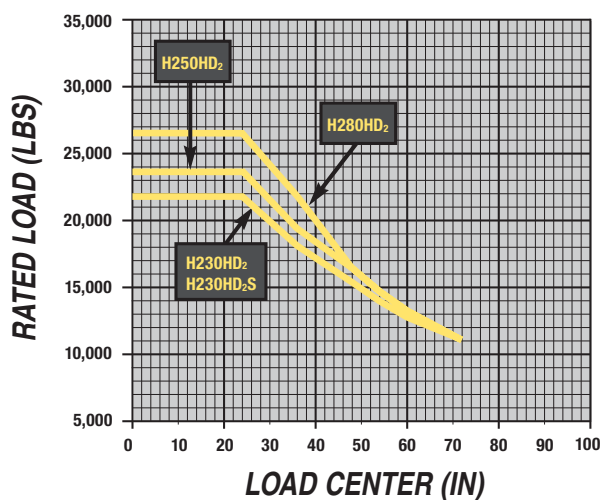

## RATED LOAD VS. LOAD CENTER

Dual Function Sideshifting /  
 Fork Positioning Carriage  
 U.S. CUSTOMARY

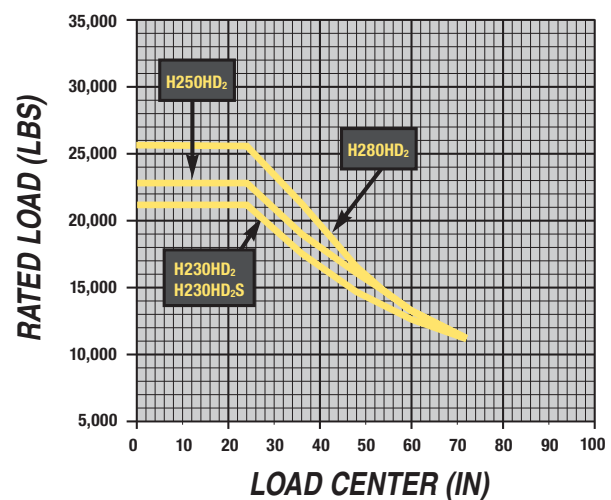

Conversion Factor: 1.0" = 25.4 mm; 1 lb = 0.45 kg

# HYSTER H300HD<sub>2</sub> - H360HD<sub>2</sub> LIFT TRUCK RATED CAPACITIES

Model H300HD<sub>2</sub>: 30,000 lbs. at 24" (13,608 kg at 600 mm) load center.  
 Model H330HD<sub>2</sub>: 33,000 lbs. at 24" (14,969 kg at 600 mm) load center.  
 Model H360HD<sub>2</sub>: 36,000 lbs. at 24" (16,329 kg at 600 mm) load center.

Rated capacities are for trucks equipped with:

- VISTA® mast to 212.0" (5400 mm) (H300-360HD<sub>2</sub>) maximum fork height
- 98.5" (2,502 mm) (H300-360HD<sub>2</sub>) carriage
- 72.0" (1,829 mm) (H300-360HD<sub>2</sub>) long forks as required

Contact your dealer for other capacity information.

**RATED LOAD VS. LOAD CENTER**  
 Non-Sideshift Fork Positioning Carriage  
 U.S. CUSTOMARY

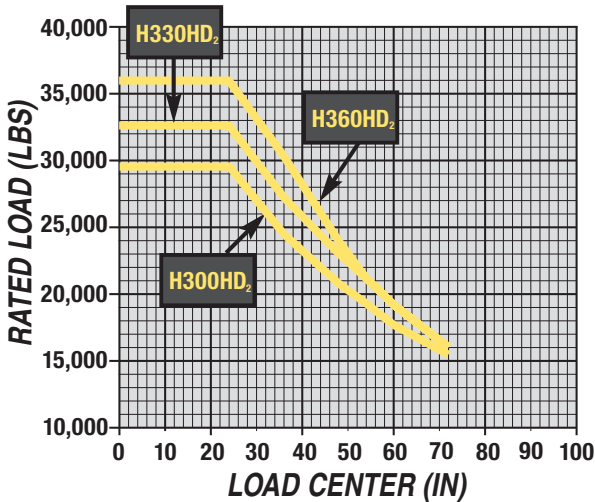

**RATED LOAD VS. LOAD CENTER**  
 Integral Sideshift Carriage/Apron Style  
 Sideshifting Fork Positioning Carriage  
 U.S. CUSTOMARY

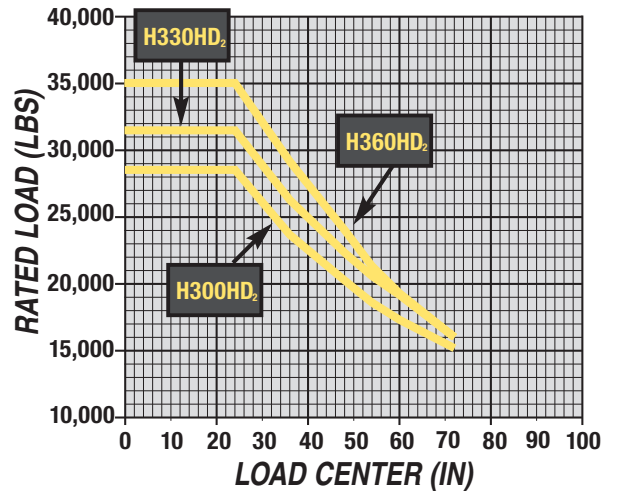

**RATED LOAD VS. LOAD CENTER**  
 Non-Sideshift Fork Positioning Carriage  
 U.S. CUSTOMARY

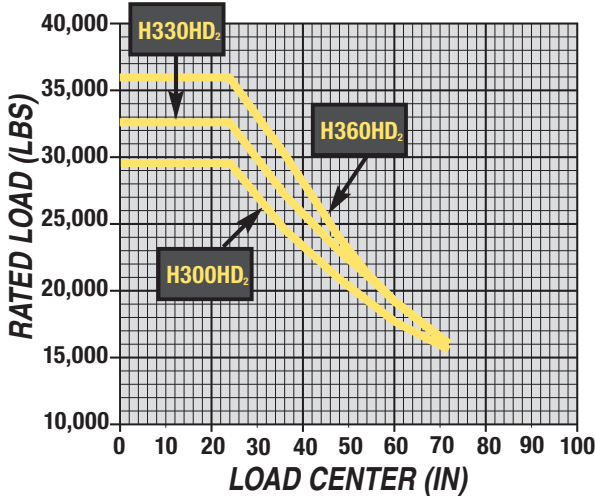

**RATED LOAD VS. LOAD CENTER**  
 Dual Function Sideshifting/Fork Positioning Carriage  
 U.S. CUSTOMARY

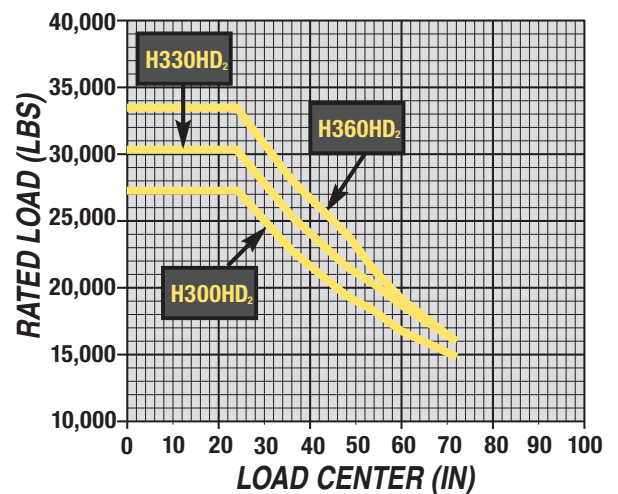

# H190HD<sub>2</sub> - H360HD<sub>2</sub> SPECIFICATIONS

MODEL	A	B	C	D	E	F	G
	in. (mm)	in. (mm)	in. (mm)	percent	in. (mm)	in. (mm)	in. (mm)
H190HD <sub>2</sub>	116.8 (2967)	119.4 (3033)	72.3 (1837)	70.0%	25.7 (653)	31.8 (809)	46.5 (1181)
H210HD <sub>2</sub>	116.8 (2967)	119.4 (3033)	72.3 (1837)	70.0%	25.7 (653)	31.8 (809)	46.5 (1181)
H230HD <sub>2</sub>	116.8 (2967)	119.4 (3033)	72.3 (1837)	75.0%	25.7 (653)	31.8 (809)	46.5 (1181)
H250HD <sub>2</sub>	116.8 (2967)	119.4 (3033)	72.3 (1837)	75.0%	25.7 (653)	31.8 (809)	46.5 (1181)
H280HD <sub>2</sub>	116.8 (2967)	119.4 (3033)	72.3 (1837)	75.0%	25.7 (653)	31.8 (809)	46.5 (1181)
H300HD <sub>2</sub>	118.0 (2990)	120.6 (3064)	74.7 (1899)	86.9%	26.9 (684)	31.8 (809)	46.5 (1181)
H330HD <sub>2</sub>	118.0 (2990)	120.6 (3064)	74.7 (1899)	86.9%	26.9 (684)	31.8 (809)	46.5 (1181)
H360HD <sub>2</sub>	118.0 (2990)	120.6 (3064)	74.7 (1899)	86.9%	26.9 (684)	31.8 (809)	46.5 (1181)

MODEL	STEP HEIGHT				
	in. (mm)	S1	S2	S3	S4
H190HD <sub>2</sub>		15.51 (394)	27.87 (708)	40.24 (1022)	52.60 (1336)
H210HD <sub>2</sub>		15.51 (394)	27.87 (708)	40.24 (1022)	52.60 (1336)
H230HD <sub>2</sub>		15.51 (394)	27.87 (708)	40.24 (1022)	52.60 (1336)
H250HD <sub>2</sub>		15.51 (394)	27.87 (708)	40.24 (1022)	52.60 (1336)
H280HD <sub>2</sub>		15.51 (394)	27.87 (708)	40.24 (1022)	52.60 (1336)
H300HD <sub>2</sub>		18.07 (420)	30.09 (764)	42.11 (1070)	54.13 (1375)
H330HD <sub>2</sub>		18.07 (420)	30.09 (764)	42.11 (1070)	54.13 (1375)
H360HD <sub>2</sub>		18.07 (420)	30.09 (764)	42.11 (1070)	54.13 (1375)

MODEL	CARRIAGE in. (mm)				
	Standard	FP*	Sideshift	SSFP**	DFSSFP***
H190-210HD <sub>2</sub> (2-Stage)	28.5 (725)	30.5 (775)	30.9 (785)	30.9 (785)	32.9 (836)
H190-210HD <sub>2</sub> (3-Stage)	34.8 (885)	34.8 (885)	35.9 (911)	35.9 (911)	N/A
H230-280HD <sub>2</sub> (2-Stage)	29.9 (760)	31.9 (810)	32.2 (819)	32.2 (819)	33.9 (861)
H230-280HD <sub>2</sub> (3-Stage)	34.8 (885)	34.8 (885)	35.9 (911)	35.9 (911)	N/A
H300-360HD <sub>2</sub> (2-Stage)	33.9 (862)	33.9 (862)	35.3 (896)	35.3 (896)	37.4 (949)
H300-360HD <sub>2</sub> (3-Stage)	36.9 (937)	36.9 (937)	39.8 (1012)	39.8 (1012)	N/A

\*FP - Fork Positioner

\*\*SSFP - Sideshift Fork Positioner

\*\*\*DFSSFP - Dual Function Sideshift Fork Positioner

# STANDARD FEATURES AND OPTIONS

## STANDARD EQUIPMENT

Hyster H190-360HD<sub>2</sub> trucks are equipped with:

- low-emissions, Cummins turbo-charged diesel engine
- 70 amp alternator
- overhead exhaust
- Hyster 3-speed autoshift transmission
- telescopic, tilt steering wheel
- planetary drive axle
- air brakes with air system drier
- 212.0" (5,400 mm) 2-stage no FL VISTA® mast
- 92.5" (2,350 mm) (H190-280HD<sub>2</sub>), 98.5" (2,502 mm) (H300-360HD<sub>2</sub>) pin-type carriage
- 48.0" (1,219 mm) (H190-280HD<sub>2</sub>), 72.0" (1,829 mm) (H300-360HD<sub>2</sub>) forks
- 2 brake w/backup lights
- puller engine fan
- MONOTROL® pedal
- side view mirrors
- horn
- operator restraint system
- 12 volt auxiliary power source
- overhead guard
- operating manual
- 15° forward / 12° back mast tilt
- operator compartment features:
  - seat-side hydraulic control
  - independently adjustable armrest
  - multifunction display panel
  - wide angle mirrors
  - manual operator compartment side tilt for service access
  - isolated mounting
  - handrails for operator entry and exit
  - mechanical full suspension vinyl seat
  - floormat
- load sensing steering
- parts manual
- 10.00 x 20-20 PR premium SuperLug off road tires (190-280HD<sub>2</sub>)
- 12.00 x 20-16 PR premium SuperLug off road tires (300-360HD<sub>2</sub>)
- integral air precleaner
- U.L. Classification D

## OPTIONAL EQUIPMENT INCLUDES:

- lever directional control
- spinner knob
- solid or radial tires
- wet disc brakes
- Premium ZF WG161 3 speed Autoshift transmission
- High performance Power on Demand hydraulic system
- Hydraulic protection system
- Unconditional travel speed limiter
- Loaded travel speed limiter
- ComforCab II features: electric wiper & windshield washers-front, rear & top; heater & defroster; 3-speed fan; additional circulation fan; intermittent front wiper; tinted, curved glass; steel frame glass doors; door retainer; dome light; 12 volt auxiliary power source
- Cab only options: air conditioning with sunshade, reading light, rear locking console, sunshade
- cloth mechanical suspension seat (w/cab only)
- vinyl air suspension seat
- cloth air suspension seat (cab only)
- raintop (for non-cab trucks)
- 0.66 gallon (2.5 liter) piston type accumulator
- 20.5° forward / 7° back mast tilt (2-stage )
- 15° forward / 10° back mast tilt (2 & 3-stage )
- 5° forward / 6° back mast tilt (3-stage )
- various light packages
- turn signals
- amber strobe light
- back-up alarm
- exhaust aspirated air precleaner
- SyKlone Precleaner
- variable mast heights
- 3, 4, 5 and 6 function valve and hose groups
- joystick hydraulic control
- hydraulic control lever options
- Carriage options: integral pin-type fork positioner with simultaneous or individual fork control; pin-type integral sideshift; integral pin-type dual function sideshift fork positioner; apron style sideshift fork positioner with simultaneous or individual fork control
- polished and tapered forks (H190-280HD<sub>2</sub>)
- variable fork lengths
- powered operator compartment side tilt for service access
- Radio preparation package
- steer wheel lug protection rings

# STANDARD FEATURES AND OPTIONS

## MASTS

Mast with nested channels provide excellent visibility of the attachment and load. Pre-lubed and sealed load rollers resist load forces.

## CARRIAGES

Pin-type; integral pin-type fork positioner with simultaneous or individual fork control; pin-type integral sideshift; integral pin-type dual function sideshift fork positioner; apron style sideshift fork positioner with simultaneous or individual fork control.

Overall width: 98.11" (2,492 mm) for the H190-280HD<sub>2</sub>. Overall width for the H300-360HD<sub>2</sub> is 102.62" (2,667 mm)

Minimum inside-to-inside fork spacing - model and attachment dependent: ranges from 2.9" - 5.5" (75 mm - 140 mm)

Maximum outside-to-outside fork spacing - model and attachment dependent: ranges from 85.6" - 95.2" (2,176 mm - 2,420 mm)

## FORKS

2.5" x 8.0" x 48.0" - 60.0" (64 x 203 x 1,219 - 1,524 mm) pallet forks for H190-210HD<sub>2</sub>

2.5" x 8.0" x 48.0" - 72.0" (64 x 203 x 1,219 - 1,829 mm) pallet forks for H190HD<sub>2</sub>

3.0" x 8.0" x 48.0" - 96.0" (76 x 203 x 1,219 - 2,438 mm) pallet forks for H190-280HD<sub>2</sub>

3.0" x 8.0" x 48.0" - 72.0" (76 x 203 x 1,219 - 1,829 mm) polished and tapered forks for H190-280HD<sub>2</sub>

2.75" x 8.0" x 48.0" - 96.0" (70 x 203 x 1,219 - 2,438 mm) dual function sideshifting fork positioner forks for H190-280HD<sub>2</sub>

3.5" x 8.0" x 72.0" - 96.0" (89 x 203 x 1,829 - 2,438 mm) pallet forks for H300-360HD<sub>2</sub>

## ENGINE

Cummins QSB 6.7Liter -155 hp Tier 3 compliant engine features:

- 4 cycle; 6 cylinders; 409 cu. in. (6702 cm<sup>3</sup>) displacement
- Maximum torque is 440 ft.lbs. (597 N•m) at 1,500 RPM
- Turbocharged and intercooled for maximum efficiency
- U.L. Classification D
- 4.02" (102 mm) bore
- 4.72" (120 mm) stroke
- Engine compartment features gull-wing doors for easy service access

## TRANSMISSION

- Exclusive Hyster TE-10 three-speed, fully-reversing powershift transmission produces smooth shifting, precise inching and fast acceleration
- Cushioned clutch lock-up provides smooth shifting and dampens drive line shock loads
- Standard steer column mounted lever provides the operator the option of manual shift capabilities
- A dash-mounted indicator light displays transmission mode status
- A premium ZF WG161 transmission option is available for additional travel speed, drawbar pull, or for use in rugged applications

## HYDRAULIC SYSTEM

- 3,050 PSI (21.0 mPa) hydraulic lift system; 2,400 PSI (16.5 mPa) relief pressure in all auxiliary valve variations
- Electro proportional hydraulic control valve sections allow precise metering of hydraulic functions
- "O" Ring Face Seal hydraulic fittings are used throughout the hydraulic system

# STANDARD FEATURES AND OPTIONS

## STEERING SYSTEM

- The steer axle is a casting with a transverse mounted double acting cylinder, 2 non-adjustable tie rods, 2 spindles, taper roller bearings and 2 wheel hubs. The axle is pin mounted to the frame
- Designed for high loads and long life, the one piece axle frame carries the axle loads and provides mounting for the spindles and cylinder
- Axle spindles are supported by tapered roller bearings and sealed to prevent contamination entry or loss of grease
- Eight high tensile bolts secure the steer cylinder providing large wheel angles and greater maneuverability. Excessive external force on the frame is avoided using this design
- No steering linkage adjustments are required. Lubricating fittings on the spindle and tie rod pins are the only regular maintenance points
- Load sensed steering provides low steering effort and good performance at all engine speeds

## DRIVE AXLE

Rugged Hyster drive axle features full-floating design. Wheel hubs rotate on large tapered roller bearings. Non-adjustable tie rod ends provide maximum life.

## BRAKES

- Standard “S-cam”-style, power-assist air brakes provide smooth, reliable braking with minimal effort
- A dedicated compressor air filter and air system dryer provides clean, unrestricted air supply to the braking system
- Non-asbestos brake linings
- An optional oil cooled wet disc brake system is also available to greatly extend brake system life

## OPERATOR AREA



- Instruments are in the operator’s line of sight
- Ergonomically designed hydraulic controls and high/low range control lever are within easy reach
- Three steps and handgrips provide easy access to operator compartment
- Angled floor plate and pedals are positioned for operator comfort
- Standard MONOTROL® pedal controls engine speed and truck direction, freeing operator hands to operate steering and hydraulic controls
- Telescopic, tilt steer column
- Supportive mechanical full-suspension seat adjusts 8-inches (200 mm) for operator comfort
- Several air suspension seat options are available
- Steel overhead guard frame provides excellent high-stacking visibility
- Operator Presence System (OPS) with complete hydraulic lock out requires the operator to be in the normal operating position before any travel or movement of the mast, tilt, carriage, and attachment can be initiated and that the travel or movement of the mast, tilt, carriage, and attachment is locked out when the operator leaves the seat for more than 2-3 seconds
- Optional light groups aid visibility in low-lighted areas
- Optional ComforCab II features: tinted, curved glass; circulation fan; heater & defroster; electric wiper and windshield washer front, rear, top; intermittent front wiper; door retainer; 3 speed fan; 12 volt auxiliary power source; dome light, with many additional options to enhance comfort and productivity.

*Special attachments, equipment or accessories not listed above may be available through Applications Engineering for specific application requirements.*



Hyster Company  
P.O. Box 7006  
Greenville, North Carolina  
27835-7006  
Part No. H190-360HD2/TG  
1/2011 Litho in U.S.A.

Visit us online at [www.hysteramericas.com](http://www.hysteramericas.com) or call us at 1-800-HYSTER-1.

Hyster, , Monotrol and Fortis are registered trademarks of Hyster Company.  UNISOURCE is a trademark of Hyster Company. Hyster products are subject to change without notice.

The Hyster Company products included in this document may be covered by US Patent 6,684,148, and other patents pending. Truck on cover shown with optional equipment. ©2011 Hyster Company. All rights reserved.